

Fixed Mount Scanner

FUZZYSCAN FAMILY

Quick Start Guide

FUZZYSCAN
FIXED MOUNT SCANNER

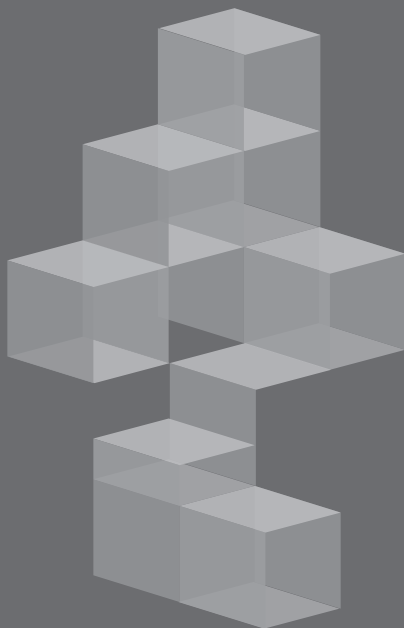

cino

Getting Familiar with Your FuzzyScan

Thank you for choosing Cino FuzzyScan Fixed Mount Scanner. Built with FuzzyScan 3.0 Imaging Technology, durable ultra-compact design and rich functionality, it provides an ideal barcode scanning solution for both industrial and general purpose applications. This document provides a quick reference for installation and operation. The complete documentation is available at www.cino.com.tw.

FM480 Series (Front-view Model)

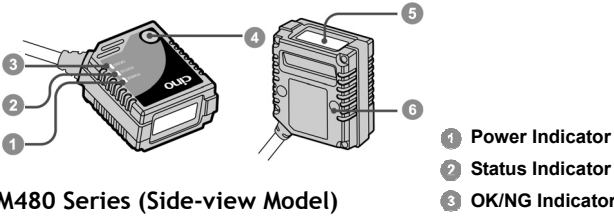

FM480 Series (Side-view Model)

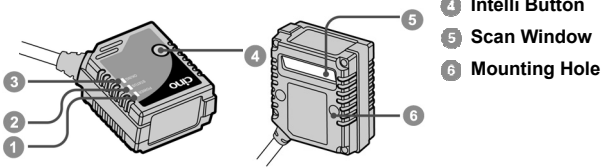

FA470 Series (Front-view Model)

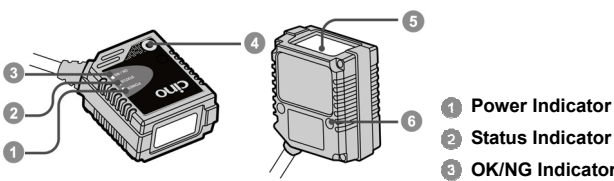

FA470 Series (Side-view Model)

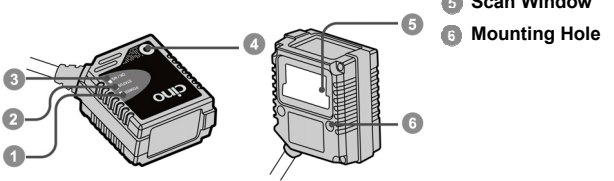

Connect to Your Host

Both standard RS232 and USB interfaces are available in different models. Each model is equipped with corresponding connector to meet various application demands.

USB Models (FM4xx-11x/FA4xx-11x)

The USB models provide a plug-and-play solution. Both USB HID and USB COM Port Emulation interfaces are available for user's choice.



4-pin Type A
Connector

Pin No.	Signal	Description	I/O Type
Case	FG	Frame Ground	---
1	VCC	---	I
2	Data -	USB Data -	I/O
3	Data +	USB Data +	I/O
4	GND	---	---

RS232 Models (FM4xx-00x/FA4xx-00x)

The RS232 models support the standard RS232 interface equipped with a 9-pin D-sub connector with power jack for external 5VDC power inlet.



9-pin D-sub
Female Connector

Pin No.	Signal	Description	I/O Type
Case	FG	Frame Ground	---
1	---	---	---
2	TXD	Transmit Data	O
3	RXD	Receive Data	I
4	---	---	---
5	GND	Signal Ground	---
6	---	---	---
7	CTS	Clear to Send	I
8	RTS	Request to Send	O
9	VCC	5Vdc Power Supply	I

Universal Models (FM4xx-98x/FA4xx-98x)

The universal models support both standard RS232 and USB interfaces with OK/NG signal outputs and external trigger input.

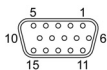

15-pin D-sub HD
Female Connector

Pin No.	Signal	Description	I/O Type
1	VCC	5Vdc Power Supply	I
2	TXD	Transmit Data	O
3	RXD	Receive Data	I
4	GND	Signal Ground	---
5	---	---	---
6	RTS	Request to Send	O
7	OK	OK Signal Output (3-24Vdc)	O
8	Data +	USB Data +	I/O
9	Trigger	External Trigger Input	I
10	CTS	Clear to Send	I
11	---	---	---
12	Data -	USB Data -	I/O
13	Shield	Frame Ground	---
14	NG	NG Signal Output (3-24Vdc)	O
15	Reserved	---	---

Install Your FuzzyScan

Adjust Reading Angle

The readability may be impacted by the specular reflection caused by the perpendicular reading angle. To get the most optimal reading performance, it is recommended to install the scanner at an approximate **15°** angle to the perpendicular line of the target barcode. However, the reading angle and distance may vary depending on the size and printing quality of barcodes.

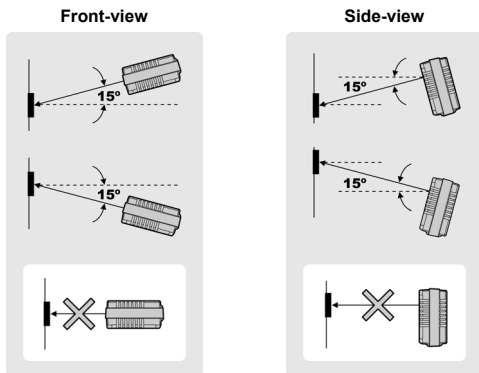

Mount Your FuzzyScan

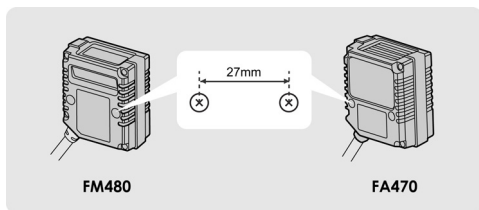

There are two **M3** mounting holes on the bottom of the chassis. Please follow below procedures to mount your scanner.

- 1 Prepare two appropriate M3 screws (minimal 4mm in depth) and decide your desired mounting location. Then adjust the two screws to accommodate **27mm** center width.
- 2 Optimize the mounting position by adjusting reading angle and distance. Ensure the illumination envelop is not blocked by any external object.
- 3 Use the **Intelli Button** to verify the actual reading rate. If the reading rate is not good enough, please adjust the reading angle and distance to get the optimum readability.

Intelli Button

For normal operation, the Intelli Button of the scanner acts as a manual **Trigger Switch**. You can press the Intelli Button to scan the corresponding barcode commands to configure your scanner with ease. Moreover, the useful Intelli Button can help you to identify the best mounting position. Please refer to following descriptions for more details.

Optimize Your Installation

Once the mounting position for the scanner is determined, you may use the Intelli Button to optimize the mounting position with ease. Please follow below procedures to use the Intelli Button.

- 1 Press and hold the Intelli Button for more than **5** seconds until the status indicator gives one green blink, then release the button. The scanner will emit 2 short beeps and the power indicator will flash blue blink per 1 second to indicate the force reading process is activated. The scanner will turn on the light source to scan barcodes continuously until the whole process completed.
- 2 Keep the scanner to read the same barcode. The scanner will count the **Good Read** numbers, then output the information of reading rate and refresh LED indications every 100 scans. The format of output message is listed below.

< Readout data > : < Reading rate (0 to 100) >

Meanwhile, both Status and OK/NG indicators provide the visible reading rate information as well. You may refer to the table listed below for details.

Reading Rate	Status Indicator	OK/NG Indicator
100%	Steady Green	Steady Green
80 to 99%	Steady Red	Steady Green
50 to 79%	Steady Green	Steady Red
20 to 49%	Steady Orange	Steady Orange
0 to 19%	Steady Red	Steady Red

- 3 If the reading rate is not good enough, please adjust the reading angle and distance to get the optimum readability. If you would like to exit the force reading process, please press the Intelli Button once again.



1. If the scanner is unable to read any barcode after time-out duration (default is 900ms), the scanner will count it as a NG reading.
2. During force reading process, the OK/NG output signals will not be performed.

Use Your FuzzyScan

Both FuzzyScan **Barcode commands** and **Serial commands** are available to configure your scanner. The FuzzyScan barcode commands are a series of proprietary barcodes which allow you to easily configure the scanner for most applications. Moreover, the FuzzyScan serial commands are ideal for precise and complicated reading control in machine-controllable environments. Please refer to the relevant documentations for details.

External Trigger and Serial Trigger

The scanner provides both external trigger and serial trigger to activate the scanning processes. Please note that the external trigger is only available for universal models. The serial trigger is workable for all models including RS232 serial and USB COM Port Emulation interfaces.

User Defined Serial Trigger Command

For user's convenience to replace the other existing fixed mount scanner, the useful user defined serial trigger command allows you to trigger the scanner without impacting the existing application programs.

Scan Input Time-out

The scan input time-out is an adjustable value for the time period that light source turns on. It's available for presentation, alternative and level modes. The scanner keeps the light source on and continues to scan until the defined scan input time-out is up. You can adjust the time-out duration from 100 milliseconds to 99 seconds to meet various application demands.

OK and NG Outputs

The universal models support additional OK and NG outputs for more precise reading control. If the scanner got a good read, a signal will be outputted through the OK pin. However, if the scanner failed to read the barcode during a reading cycle or preset scan input time-out, a signal will be outputted through the NG pin.

The OK and NG outputs are designed as **NPN** signal outputs and preset to active low. If necessary, you can change the active state of OK and NG outputs to meet your applications.

Operation Modes

The FuzzyScan Fixed Mount Scanner provides five different operation modes, including trigger, alternative, level, presentation and force modes to meet various application demands.

Both the presentation and force modes support **triggerless** operation, you don't need to use either external trigger or serial trigger to activate the scanning. But the trigger, alternative and level modes **have to** work with **external trigger** or **serial trigger** to scan barcode.

Operation Mode **A** area-imaging fixed mount scanner

The details of each operation mode supported by **FA470** area-imaging fixed mount scanner are listed below.

A



Trigger Mode

Under trigger mode, the scanner will turn on the light source to read barcode when it receives an external trigger or a serial trigger ON command. Once the external trigger has been released, or the scanner gets a good read or a serial trigger OFF command, the scanner will stop reading and wait for the next trigger to activate scanning again.

A



Alternative Mode

When the scanner receives an external trigger or a serial trigger ON command under alternative mode, the scanner will turn on the light source to read barcodes until the **preset scan input time-out** is up. The scan input time-out will be reset after each good read. Once the light source goes off, the scanner is waiting for the next trigger to activate scanning again.

A



Level Mode

When the scanner receives an external trigger or a serial trigger ON command under level mode, the scanner will turn on the light source to read barcodes until **a good read** is performed or the **preset scan input time-out** is up. Once the light source goes off, the scanner is waiting for the next trigger to activate scanning again.

A



Presentation Mode

When presentation mode is selected, the scanner is preset to turn on the background lighting to detect the bar codes. Once the scanner detects an image similar to a bar code in the scanner field of view, it will turn on the light source to scan until the **preset scan input time-out** is up. You may adjust the setting of "Presentation Sensitivity" to increase the detection sensitivity.

A



Force Mode

Under force mode, the scanner continues to read barcodes without using external trigger or serial trigger. Please note that the scanner will not stop reading until you switch to another operation mode.

Operation Mode **F** linear fixed mount scanner

The details of each operation mode supported by **FM480** fixed mount scanner are listed below.

F



Trigger Mode

Under trigger mode, the scanner will turn on the light source to read barcode when it receives an external trigger or a serial trigger ON command. Once the external trigger has been released, or the scanner gets a good read or a serial trigger OFF command, the scanner will stop reading and wait for the next trigger to activate scanning again.

F



Alternative Mode

When the scanner receives an external trigger or a serial trigger ON command under alternative mode, the scanner will turn on the light source to read barcodes until the **preset scan input time-out** is up. The scan input time-out will be reset after each good read. Once the light source goes off, the scanner is waiting for the next trigger to activate scanning again.

F



Level Mode

When the scanner receives an external trigger or a serial trigger ON command under level mode, the scanner will turn on the light source to read barcodes until **a good read** is performed or the **preset scan input time-out** is up. Once the light source goes off, the scanner is waiting for the next trigger to activate scanning again.

F



Presentation Mode

Under presentation mode, the scanner will automatically detect the object movement in the scanner field of view. Once the scanner detects an image similar to a barcode, it will turn on the light source to scan until the **preset scan input time-out** is up. For dark environments, you may adjust the setting of "Presentation Sensitivity" to increase the detection sensitivity.

F



Force Mode

Under force mode, the scanner continues to read barcodes without using external trigger or serial trigger. Please note that the scanner will not stop reading until you switch to another operation mode.

Host Interface Quick Set



RS232 Serial



USB HID Turbo Mode



USB HID Standard Mode



USB Com Port Emulation

USB HID Interface Quick Set

- Record Suffix -



None



TAB



ENTER



RETURN ◆



SPACE

- Keyboard Layout -



USA ◆



Germany



Canadian French



Latin America



Japan



France



United Kingdom-UK



Spain



Netherlands

Serial Interface Quick Set

- Record Suffix -



None



CR ◆



LF



CRLF



TAB



SPACE

- Baud Rate -



38.4K BPS



19.2K BPS



9600 BPS ◆



4800 BPS



2400 BPS



1200 BPS



600 BPS



300 BPS

- Data Frame -



8, None, 1 ◆



8, Odd, 1



8, Even, 1



8, Space, 1



8, Mark, 1



8, None, 2



7, Odd, 1



7, Even, 1



7, Space, 1



7, Mark, 1



7, None, 2



7, Odd, 2



7, Even, 2







7, Space, 2











7, Mark, 2

USB HID Interface Control

Command	Parameter Selection		Option Code	
Keyboard Layout 	USA ◆ France Germany United Kingdom-UK Canadian French Spain Sweden/Finland Portugal Norway	Latin America Italy Netherlands Denmark Belgium Switzerland-Germany Iceland Japan Universal	00 01 02 03 04 05 06 07 08	09 10 11 12 13 14 15 16 19
Record Suffix 	None RETURN ◆ TAB SPACE	ENTER User define character	0 1 2 3	4 5
Preamble 	None ◆ 1-15 characters		FIN [00-7F], [FIN]	
Postamble 	None ◆ 1-15 characters		FIN [00-7F], [FIN]	
Intermessage Delay 	None ◆ 1-99 (x5) msec.		FIN (2 digits)	
Intercharacter Delay 	None ◆ 1-99 (x5) msec.		FIN (2 digits)	
Interfunction Delay 	None ◆ 1-99 (x5) msec.		FIN (2 digits)	
Caps Lock Control 	"Caps Lock Off" State ◆ "Caps Lock On" State Auto Detect		0 1 2	
Caps Lock Release Control 	"Caps Lock On, Caps Off" ◆ "Caps Lock On, Shift Off"		0 1	
Function Key Emulation 	Enable ASCII 00-31 as KB function code output ◆ Enable ASCII 00-31 as Ctrl-xx output		0 1	
Key Pad Emulation 	Disable key pad emulation ◆ Enable numeric output as key pad output		0 1	
Upper/Lower Case 	Normal case ◆ Inverse case Upper case Lower case		0 1 2 3	

Serial Interface Control

Command	Parameter Selection		Option Code	
STX/ETX Control 	Disable STX/ETX transmission ◆ Enable STX/ETX transmission		0 1	
Record Suffix 	None CR ◆ LF CRLF	TAB SPACE User define character	0 1 2 3	4 5 6
Preamble 	None ◆ 1-15 characters		FIN [00-7F], [FIN]	
Postamble 	None ◆ 1-15 characters		FIN [00-7F], [FIN]	
Handshaking Protocol 	None ◆ RTS/CTS ACK/ NAK Xon/Xoff		0 1 2 3	
Intermessage Delay 	None ◆ 1-99 (x5) msec.		FIN (2 digits)	
Intercharacter Delay 	None ◆ 1-99 (x5) msec.		FIN (2 digits)	
Interfunction Delay 	None ◆ 1-99 (x5) msec.		FIN (2 digits)	
Serial Response Time-out 	None 200 msec. 500 msec. ◆ 800 msec. 1 sec. 2 sec	3 sec. 4 sec. 5 sec. 8 sec. 10 sec. 15 sec.	0 1 2 3 4 5	6 7 8 9 A B

Message String Breakdown

USB HID interface output (DOS/V, USB HID)

Preamble	Data Length	Prefix ID	Scanned Data	Suffix ID	Postamble	Record Suffix
1-15 char.	2-4 digits	1 or 3 char.	Variable	1 or 3 char.	1-15 char.	1 char.









Serial interface output (RS-232, USB COM Port Emulation)

STX	Preamble	Data Length	Prefix ID	Scanned Data	Suffix ID	Postamble	ETX	Record Suffix
1 char.	1-15 char.	2-4 digits	1 or 3 char.	Variable	1 or 3 char.	1-15 char.	1 char.	1 char.

Operation Control

Command	Parameter Selection	Option Code
Redundancy 	None Level 1 ◆ Level 2 Level 3 Level 4 Level 5 Scan Voting	0 1 2 3 4 5
Power On Indicator 	Disable (LED off) LED steady on ◆ LED flash	0 1 2
Buzzer Tone Control 	Buzzer tone – mute Buzzer tone – low Buzzer tone – medium ◆ Buzzer tone – high Buzzer tone – extremely high Power-on beep ◆ No Power-on beep	0 1 2 3 4 5 6
Good Read Duration 	Short Medium ◆ Long Extremely long Extremely short	0 1 2 3 4
Presentation Sensitivity 	Level 1 Level 2 Level 3 Level 4 Level 5 ◆ Level 6 Level 7	0 1 2 3 4 5 6
Scan Rate Control 	Dynamic ◆ Fixed	0 1
Hands Free Time-out 	Short ◆ Medium Long Extremely long Disable	0 1 2 3 4
Scan Input Time-out 	100 msec. 200 msec. 300 msec. 400 msec. 500 msec. 600 msec. 700 msec. 800 msec. 900 msec. ◆ User define: 1-99 sec.	0 1 2 3 4 5 6 7 8 9, (2 digits)

Output Control

Command	Parameter Selection	Option Code
Dollar Sign Output 	Dollar sign output as "\$" ◆ Dollar sign output as "¥" Dollar sign output as "€" Dollar sign output as "£" Dollar sign output as "¢"	0 1 2 3 4
Good Read Delay 	None ◆ 200 msec. 500 msec. 1 sec. 1.5 sec. 2 sec. 3 sec.	0 1 2 3 4 5 6
Reread Delay 	Disable Immediate time out ◆ Short time out Medium time out Long time out Force verification Double Scan Verification	0 1 2 3 4 5
OK/NG Signal Active States 	OK low/NG low ◆ OK low/NG high OK high/NG low OK high/NG high	0 1 2 3
OK/NG Signal Output Control 	Disable OK/NG output Enable NG output Enable OK output Enable OK/NG output ◆	0 1 2 3
OK/NG Signal Duration 	10 msec. 20 msec. 30 msec. 40 msec. 50 msec. 60 msec. 70 msec. 80 msec. 90 msec. 100 msec. ◆ User define: 1-99 (x50) msec.	0 1 2 3 4 5 6 7 8 9 A, (2 digits)
OK/NG Beeping Control 	Disable OK and NG beep Enable OK and NG beep ◆ Enable OK beep and disable NG beep Enable NG beep and disable OK beep	0 1 2 3
Symbology ID Transmission 	Disable symbology ID transmission ◆ Enable prefix CINO symbology ID transmission Enable suffix CINO symbology ID transmission Enable prefix and suffix CINO symbology ID transmission Enable prefix AIM symbology ID transmission Enable suffix AIM symbology ID transmission Enable prefix and suffix AIM symbology ID transmission	0 1 2 3 4 5 6

System Commands



PROGRAM
(Enter Programming Mode)



END
(Exit Programming Mode)



Factory Default



System Information



PowerTool Host Link



Master Default



Save User Default



User Default

Option Codes



0



1



2



3



4



5



6



7



8



9



A



B



C



D



E



F



FIN (Finish)



END (Exit)

FuzzyScan Fixed Mount Scanner Quick Start Guide
International Edition, Rev. B1



P/N: YMAUB70010010R0

Disclaimer

Cino makes no warranty of any kind with regard to this publication, including, but not limited to, the implied warranty of merchantability and fitness for any particular purpose. Cino shall not be liable for errors contained herein or for incidental consequential damages in connection with the furnishing, performance, or use of this publication. This publication contains proprietary information that is protected by copyright. All rights are reserved. No part of this publication may be photocopied, reproduced or translated into any language, in any forms, in an electronic retrieval system or otherwise, without prior written permission of Cino. All product information and specifications shown in this document may be changed without prior notice.

© COPYRIGHT CINO GROUP • PC WORTH INT'L CO., LTD. ALL RIGHT RESERVED.

Warranty

Cino warrants its products against defects in workmanship and materials from the date of shipment, provided that the product is operated under normal and proper conditions. The warranty provisions and durations are furnished by different warranty programs. The above warranty does not apply to any product which has been (i) misused; (ii) damaged by accident or negligence; (iii) modified or altered by the purchaser or other party; (iv) repaired or tampered by unauthorized representatives; (v) operated or stored beyond the specified operational and environmental parameters; (vi) applied software, accessories or parts are not supplied by Cino; (vii) damaged by circumstances out of Cino's control, such as, but not limited to, lightning or fluctuation in electrical power. Any defective product must follow the warranty program and RMA procedures to return Cino for inspection.

Regulatory



FCC part 15B



Industry Canada ICES-003



EN55022, EN55024,
EN61000-3-2, EN61000-3-3



CNS13438



Clause 3, Article 58-2 of Radio Waves Act.

LED Eye Safety

IEC62471 Exempt group



V-3/2011.04, TECHNICAL REQUIREMENTS,
Class B ITE